

Article number: 021816011222

Description: Clamp with bracket and rubber  
SPGU 6011. 222/30 SK

## Measures

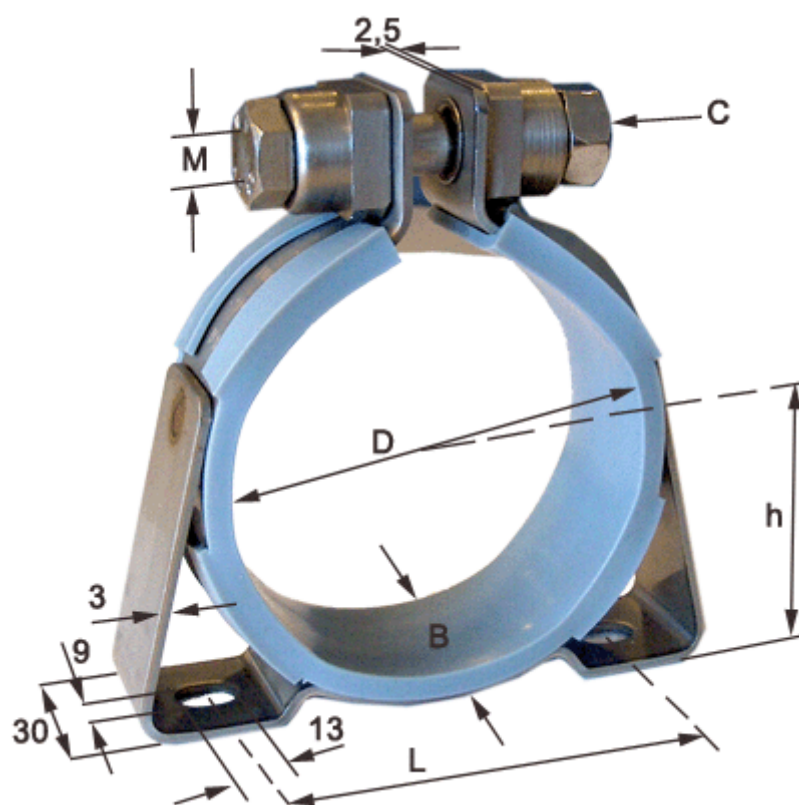

C (screw type) = SK hexagon screw

Diameter D = 222

h = 119

L = 216

Width B = 30